

SECTION XIII
FBI LABORATORY REPORTS

GRAND JURY MATERIAL - DISSEMINATE ONLY
PURSUANT TO RULE 6 (e), Fed. R. Crim. P.

#10

Inventory of items seized by SBI Agent [redacted] on a search of a 1962 light blue, Ford Fairlane, Lic# [redacted]. Pursuant to a search warrant issued November 6, 1979. Applicant on search warrant was Det. [redacted] GPD. Warrant served by S/A [redacted] at 7:28 PM, November 6, 1979.

b6
b7C

1. 19, latent print lifts.
2. 6, 357 mag. cartridge cases.
3. 3, 38 cal. cartridge cases.
4. 1, 00 buck, 12 ga. shot gun shell.
5. 1, rifle slug, 12 ga. shot gun shell.
6. 1, red, white and black, NAZIS arm band.
7. 1, white paper towel.
8. 1, pocket knife.
9. Misc. papers from glove compartment.
10. 1, white plastic bag.
11. One receipt for, one AR-15 rifle, in name of [redacted]
12. Misc. papers from back seat.
13. 1, white paper bag.
14. 1, receipt for a Dan Wesson in trade for a Star BM 9MM in name of [redacted]
15. 1, blood stained hubcap from the right front ~~XXXX~~ wheel.

b6
b7C

All the above items ~~Controlled by SBI Agent~~ are being turned over to GPD Lab. Supervisor [redacted] by S/A [redacted] on 11-8-79.

Rec. By [redacted]

From: [redacted]

FBI Lab Reports

12-19-79 Firearms
 Microscopic Analysis
 Chemicals Analysis
 Instrumental Analyses
 Metallurgy

1-7-80 Firearms
 K 44, K 45, K 46

1-14-80 Firearms - Blood Tests
 Microscopic Analyses
 Chemical Analyses
 Instrumental Analyses
 Metallurgy

1-23-80 Firearms
 Microscopic Analyses
 Chemical Analyses
 Instrumental Analyses
 Metallurgy

3-21-80 Firearms
 Serology
 Microscopic Analyses
 Instrumental Analyses
 Chemical Analyses
 Document

4-15-80 Firearms
 Serology
 Microscopic Analyses
 Instrumental Analyses
 Chemical Analyses
 Document

6-5-80 Firearms
 K 7, K 8, K 13

6-12-80 Firearms
 Serology
 Microscopic Analyses
 Instrumental Analyses
 Chemical Analyses
 Document

6-27-80 Firearms
 K 13

7-10-80 Firearms

7-18-80 Instrumental Analyses

8-21-80 Sound Analyses

4-21-82 Ballance - (A D)

6-17-82 Firearms
 K 47, K 48, K 49
 Instrumental Analyses

6-30-82 Firearms
 Instrumental Analyses
 (Tom Clark)

7-6-82 Duplication of tapes

FIREARMS

**REPORT
of the**



**FEDERAL BUREAU OF INVESTIGATION
WASHINGTON, D. C. 20535**

March 21, 1980

To: Mr. W. E. Swing
Chief of Police
Greensboro, North Carolina 27420

Attention: Captain [redacted]
Staff Services Division

FBI FILE NO.

44-81521

LAB. NO.

00212051 S/D QY UF
MC RF UQ PN

Re: [redacted] AND

YOUR NO.

00220065 S QY RF

OTHERS - SUSPECTS;
JAMES WALLER, WILLIAM SAMPSON,
AND OTHERS - VICTIMS;
CRIMINAL HOMICIDE/MURDER

79-0145368b6
b7c

Examination requested by: Addressee

Reference: Letters dated February 7, 1980 and
February 19, 1980

Examination requested: Firearms - Serology - Microscopic Analyses -
Instrumental Analyses - Chemical Analyses -
Document

Specimens personally delivered by [redacted] on February 12,
1980 (00212051 S/D QY UF MC RF UQ PN):

Q411	Cartridge (6)
Q412-Q419	Eight cartridges (11)
Q420	Cartridge (not listed)
Q421-Q422	Two cartridges (14)
Q423	Cartridge (12)

Page 1

(over)

This examination has been made with the understanding that the evidence is connected with an official investigation of a criminal matter and that the Laboratory report will be used for official purposes only, related to the investigation or a subsequent criminal prosecution. Authorization cannot be granted for the use of the Laboratory report in connection with a civil proceeding.

Q424 Cartridge case (7)
Q425-Q450 Twenty-six cartridges (15)
Q451-Q452 Two shotshells (13)
Q453 Shotshell (8)
Q454-Q456 Three shotshells (10)
Q457 Shotshell (9)
Q458 Metal fragment (17)
Q459 Shot pellet fragment (16)
Q460 Leather jacket (22)
Q461 Coat (20)
Q462 Hat (18)
Q463 Wood handle (not listed)
Q464 Club (5)
Q465-Q468 Four pieces of wood (1, 2, 3, 4)
Q469 Metal tag (21)
Q470 Bandana (19)
Q471 Knife sheath (25)
Q472-Q474 Three photographs (23)
Qc475-Qc477 Three black and white photographic copies from the "[redacted] Photographs" numbered 31A, 32A, 33A

ALSO SUBMITTED:

Bracelet (not listed)
Plastic pouch (not listed)

RESUBMITTED FROM LAB #91119065 S QY:

K13 12-gauge Mossberg shotgun, Model 500-A,
Serial Number G033005 (24)

Specimens personally delivered by on February 20, 1980 (00220065 S QY RF):

Q475-Q481 Seven fence posts (1)
Q482 Cartridge case (2)
Q483 Metal fragment (3)
Q484 Wallet with metal fragment (4)
Q485-Q501 Seventeen shotshells (5)
Q502-Q981 Four hundred eighty cartridges (6)
Q982-Q996 Fifteen cartridges (7)
Q997-Q1035 Thirty-nine cartridges (8)
Q1036-Q1060 Twenty-five shotshells (8)
Q1061-Q1062 Two shotshells (9)
Q1063-Q1077 Fifteen cartridges (9)
Q1078-Q1080 Three cartridges (10)
Q1081-Q1213 One hundred thirty-three cartridges (11)
Q1214-Q1537 Three hundred twenty-four cartridges (12)
Q1538-Q1540 Three magazines (13)
Q1541-Q1545 Five cartridge cases (14)
Q1546-Q1949 Four hundred four cartridges (14)

ALSO SUBMITTED:

Gas mask bag (5)

Green First Aid bag (6)

Eleven cartridge boxes (7, 8, 14)

Seagrams bag (8)

Receipt (not listed in 11)

Ammunition box (12)

Driver's license and assorted documents (4)

Result of examination:

This report supplements the FBI Laboratory report relating to this case dated December 19, 1979. For a detailed listing of the previously submitted weapons, please refer to that report.

No microscopic marks of value for comparison purposes were noted in the following specimens: Q411 through Q422, Q451, Q452, Q485 through Q490, Q492, Q494, Q495, Q498 through Q1035, Q1039, Q1040, Q1045, Q1048 through Q1054, Q1058, Q1061 through Q1077, Q1079, Q1081 through Q1374, Q1376 through Q1417, Q1419 through Q1537 and Q1546 through Q1949. The absence of microscopic marks in the above-listed specimens precludes their association with any of the previously submitted weapons.

The firing pin impression in the Q423 cartridge was identified as having been produced by the K6 derringer. The Q424 cartridge case was identified as having been fired in K6.

Specimens Q425 through Q450 are 5.56mm (.223 Remington caliber) cartridges of both commercial and military manufacture. These cartridges bear extractor and ejector marks. However, the microscopic characteristics present in these marks could not be associated with either of the previously submitted K46 and K15 weapons.

The following specimens bear limited microscopic marks of value for comparison purposes; however, they could not be asso-

ciated with each other or with any of the previously submitted weapons: Q453, Q496, Q497, Q1041, Q1042, Q1055, Q1375, Q1418 and Q1545. The Q454 through Q457 shotshell and the previously submitted Q251 shotshell casing were identified as having been loaded into, extracted and ejected from the same shotgun. It is noted that the previously submitted Q251 shotshell casing was identified as having been fired in the K7 shotgun.

The Q458, Q483 and Q484 metal fragments are too mutilated to determine their source(s) and bear no microscopic marks of value for comparison purposes.

Based on weight, specimen Q459 appears to be a mutilated 00 Buck shot pellet fragment.

The FBI Laboratory maintains no data or records which would identify the source of the Q469 tag.

Twenty-two lead shot pellet fragments were removed from the Q475 through Q481 fence posts. These fragments are too mutilated to determine their original size(s).

Specimen Q482 is a .25 Auto caliber cartridge case of Remington-Peters manufacture. Based on differences in breechface marks and firing pin impressions, it was determined that Q482 could not have been fired in the previously submitted K22 pistol.

The Q491 and Q493 shotshells were identified as having been loaded into, extracted and ejected from a single weapon. However, the microscopic marks utilized in identifying specimens Q491 and Q493 with each other could not be identified with any of the previously submitted shotguns.

The Q1036 through Q1038, Q1043, Q1044, Q1046, Q1047, Q1056, Q1057, Q1059 and Q1060 shotshells were identified as having been loaded into, extracted and ejected from the K8 shotgun.

Specimens Q1078 and Q1080 are .30-30 Winchester caliber cartridges which were identified as having been loaded into, extracted and ejected from a single weapon. It is noted that no .30-30 Winchester caliber weapons have been submitted to the FBI Laboratory in this case.

Specimens Q1541 through Q1544 are .30-30 Winchester caliber cartridge cases which were identified as having been fired in a single weapon. The extractor marks present in the Q1541

through Q1544 cartridge cases are different from the extractor marks in the Q1078 and Q1080 cartridges.

No microscopic marks were noted in any of the submitted ammunition or ammunition components which could be associated with the Q1538 through Q1540 magazines.

No conclusion could be reached when comparing the individual, or jacket, depicted in the Q472 through Q474 photographs with the suspect wearing a denim style jacket depicted in the Qc475 through Qc477 photographs. Insufficient views and the lack of visible identifying characteristics prevented any determination.

It was determined that the Q460 leather jacket is the same style as the jacket worn by the suspect depicted in the Qc475 through Qc477 photographs who is holding a club and shown standing at the rear of a vehicle. One significant characteristic was noted which indicates that Q460 may be the same jacket.

Due to the lack of visible individual identifying characteristics, no conclusion could be reached as to whether Q471 is or is not identical with a similar looking item depicted in the Qc475 through Qc477 photographs.

While the general visible characteristics of the sawed-off shotgun depicted in the Qc475 through Qc477 photographs are similar to those of the K13 shotgun, a positive conclusion could not be reached due to the lack of visible identifying marks.

Nothing else of significance was noted. A photomontage is being furnished for your assistance.

The remaining requested examinations are continuing and you will be subsequently advised of the results and as to the disposition of the submitted items.

REPORT
of theFEDERAL BUREAU OF INVESTIGATION
WASHINGTON, D. C. 20535

To: Mr. William E. Swing
Chief of Police
Greensboro, North Carolina 27402

June 27, 1980

Attention: Captain [REDACTED]
Staff Services Division

FBI FILE NO. 44-81521

LAB. NO. 00623039 S QY

Re: [REDACTED]

YOUR NO. 79-0145368

b6
b7c

And others - SUSPECTS;
JAMES WALLER, WILLIAM SAMPSON,
VINCENT CAUCE, And others - VICTIMS;
CRIMINAL HOMICIDE/MURDER

Examination requested by: Addressee

Reference: Letter dated June 19, 1980

Examination requested: Firearms

Specimen:

K13 Ten shotshells loaded into, extracted and ejected
from a 12-gauge Mossberg shotgun, Model 500-A,
Serial Number G033005 submitted in Laboratory
#91119065 S QY UF MC UQ RF RU

Result of examination:

The Q453 shotshell, submitted under Laboratory
#00212051 S/D QY UF MC RF UQ PN, was identified as having
been loaded into, extracted and ejected from the weapon
represented by specimen K13.

The submitted items are being returned to your office
under separate cover by Federal Express.

This examination has been made with the understanding that the evidence is connected with an official investigation of a criminal matter and that the Laboratory report will be used for official purposes only, related to the investigation or a subsequent criminal prosecution. Authorization cannot be granted for the use of the Laboratory report in connection with a civil proceeding.



UNITED STATES DEPARTMENT OF JUSTICE

FEDERAL BUREAU OF INVESTIGATION

WASHINGTON, D.C. 20535

Chief of Police
 To: Attention: Captain [REDACTED]
 Staff Services Division
 300 West Washington Street
 Greensboro, North Carolina 27401

June 13, 1980
 In Reply, Please Refer to
 File No. 00610007 S RF

b6
 b7c

RE: [REDACTED] - SUSPECT;
 JAMES WALLER - VICTIM;
 HOMICIDE
 (Your letter 6/6/80)
 (Your number 79-0145368)

From: Director, Federal Bureau of Investigation

The FBI Laboratory has received the evidence which you sent for examination in connection with the above-entitled case. A Laboratory report will be sent to you after the examination has been completed.

The examination is being made with the understanding that the evidence is connected with an official investigation of a criminal matter and that the Laboratory report will be used for official purposes only, related to the investigation or a subsequent criminal prosecution. Authorization cannot be granted for the use of the Laboratory report in connection with a civil proceeding.

If any developments occur in this case such as dismissal of charges or guilty pleas which would eliminate the necessity for conducting the requested examinations, please advise the FBI Laboratory immediately.

VIDEO

UNITED STATES GOVERNMENT

UNITED STATES DEPARTMENT OF JUSTICE
FEDERAL BUREAU OF INVESTIGATION

Memorandum

TO : SAC, CHARLOTTE DATE: 2/14/80
 (ATTN: OSM [redacted])

FROM : SA [redacted]

SUBJECT: TRAVEL - GREENKIL ✓

b6
b7C

On 1/7/80, the following witnesses traveled to Washington, D.C., FBI Lab with the original film of the shooting incident which occurred at Everett and Carver St. in Greensboro, N.C. on 11/3/79. The travel was approved by FBIHQ after agreement had been reached with General Counsel for the respective TV stations.

The travel was necessary in order to maintain custody of the original tapes, and furnish these tapes to FBI, Engineering Lab, FBIHQ.

[redacted] Channel 2, Greensboro, N.C. to WDC and return

[redacted] Channel 8, Greensboro, N.C. to WDC and return

b6
b7C

[redacted] Channel 12, Greensboro, N.C. to WDC and return

All of the above traveled on Eastern Airlines flight from Greensboro, N.C. and all tickets were paid by GTR issued at Greensboro, N.C. on 1/7/80 by me, however, to date, none of the witnesses has returned their cancelled ticket as requested.

② Charlotte

TJB/jmg
 (2) jmg

44-3721-221

SEARCHED	INDEXED
SERIALIZED	FILED
FEB 14 1980	

1) [redacted] A b6 b7C

2) [redacted] TPB



1/14/80

Making copies of tapes at Quantico today. I picked up the evidence tapes at 8:30 am at FBIHQ. I arrived at Quantico at 9:30am.

CH 12 put information on 2 inch quad
CH 8 put information on 2 inch quad

Played 3/4 inch tapes on Sony 2850 3/4 inch UMATIC to patch panel into TEC to switcher input #11 through distribution amp #9 to 2 inch recorder.

CH 12
Making 2 inch master to be taken to PBS for slow motion
We started with CH 12 inserting time code and character generator at top of picture. The time code is on the left at top and the channel number is on the right of screen.

CH 8
Make 2 inch master to be taken to PBS for slow motion.
The time code is at the bottom left and the channel number is at the bottom right.

CH 11
Same as CH 8

CH 2
Same as CH 8

completed tapes at 12:15pm

We next made dubs of the tapes from 2 inch format to 3/4 inch with and without time code to be used in court as evidence

Channels 2, 11, 12, 8 were all duplicated.

CH 2 was completed at 2:05pm
CH 11 was completed at 2:56pm
CH 12 was completed at 3:37pm
CH 8 was completed at 3:53pm

We were assisted by Electronics Tech.

Returned evidence tapes and copies at 5:05pm ~~pm~~, to FBIHQ.

Diagrams were drawn and put in my record book.

b6
b7c

2" to 3/4"

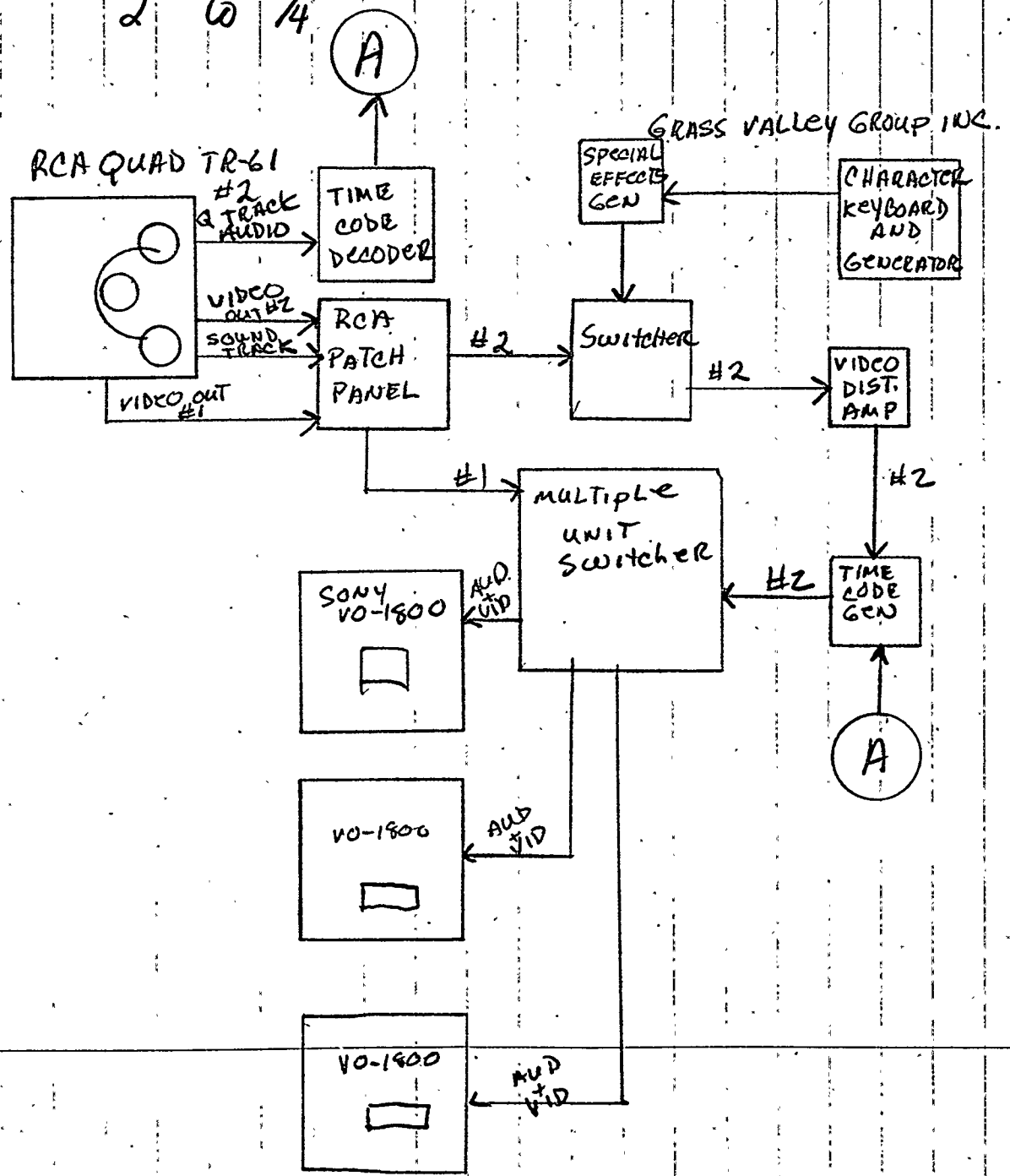

J.J.P. 1/15/80
made from rough
copy in notes.

3/4" to 2"

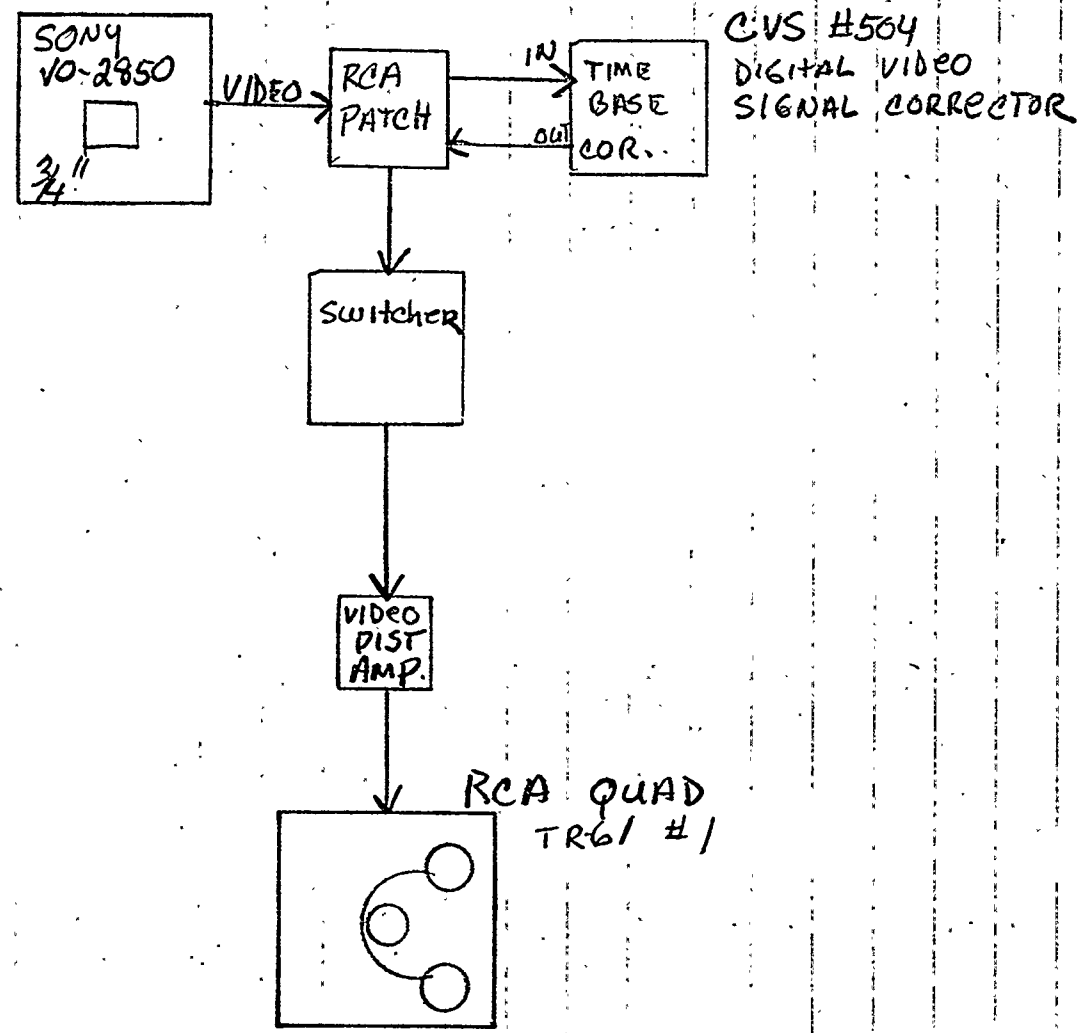

J L P. 1/15/80
Made from rough
copy in notes.

2" to 2"

RCA TR-61
QUAD #2

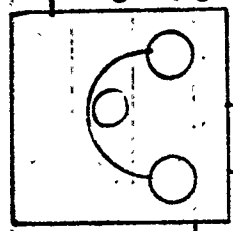

TIME
CODE
DECODER

Q TRACK
AUDIO

SOUND
TRACK
AUDIO

(A)

Q TRACK
AUDIO

SOUND
TRACK
AUDIO

RCA TR61
QUAD #1

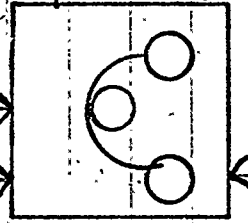

RCA
PATCH

VIDEO

RCA
VIDEO
CHAR.
GEN.

SWITCHER

GRASS VALLEY GROUP INC

SPECIAL
EFFECTS
GEN.

(A)

CHARACTER
KEYBOARD
AND
GENERATOR

DATA VISION

J.Z.P. 1/15/80
made from rough
copy in notes.

1-17-80

PBS

GREENKIL -

SLOW MOTION - WITH TIME CODE
and channel

CH-2

COPY # 1 GREENSBORO - 1/28/80

X 2 TSD

[Redacted]

7/28/80

TSD 9/8/80

CH-8

COPY # 1 GREENSBORO - 1/28/80

X 2 TSD

[Redacted]

7/28/80

TSD 9/8/80

b6
b7C

CH-11

COPY # 1 GREENSBORO - 1/28/80

X 2 TSD

[Redacted]

7/28/80

TSD 9/8/80

CH-12

COPY # 1 GREENSBORO - 1/28/80

* 2 TSD

All Copies designated #1 of Channels 2, 8, 11, & 12
shipped to SA [Redacted], Greensboro RA, Reg. Mail
(10 videocassettes) on Jan 28, 1980

b6
b7C

[Redacted]

[Redacted]

12/21/79 J.L.P.

O-4 (Rev. 8-13-79)
FEDERAL BUREAU OF INVESTIGATION
WASHINGTON, D. C. 20535

DATE: 1-28-80
TO: FBI-GREENSBORO RA
GREENSBORO, N.C.

Re: GREENKIL

att: SA

b6
b7c

Invoice of Contents

10 - Ten 3/4" videocassette copies

FBI File # 44-81521
Case # 00109030ERD

7/8027
1/28/80 AS

AS
88

All items listed above are contained in this package. A detailed description of items will be found in Bureau communication dated

Via Registered Mail

FBI/DOJ

1-14-80
Montis

● GREENKIL -

CH-2

WITH OUT TIME CODE

COPY # 1 GREENSBORO - 1/28/80
* 2 TSD - D+E

WITH TIME CODE
+ CH

COPY # 1 GREENSBORO - 1/28/80
* 2 TSD - D+E
✓ 3 [] - 1/21/80

CH-8

WITH TIME CODE
+ CH

COPY # 1 GREENSBORO - 1/28/80
✓ 2 TSD - D+E [] 7/2/80
* 3 [] - 1/21/80
- D+E 7/2/80

CH-11

WITHOUT TIME CODE

COPY # 1 GREENSBORO - 1/28/80
* 2 TSD - D+E

b6
b7c

WITH TIME CODE +
CH

COPY # 1 GREENSBORO - 1/28/80
✓ 2 TSD - D+E [] 8/1/80
✓ 3 [] - 1/21/80

CH-12

WITH TIME CODE +
CH

COPY # 1 GREENSBORO - 1/28/80
* 2 TSD - D+E
✓ 3 [] 1/21/80

DEPT. OF INVESTIGATION
J. C. 20535

Re:

GREENKIL

1/28/80
GREENSBORO RA

ATTN: SA

b6
b7C

Invoice of Contents

EVIDENCE

EVIDENCE

10 EACH 3/4 INCH VIDEO CASSETTE COPIES

Return to
Room EVIDENCE TL _____
FBI File # _____
Case # 44-81521
00109030E RD

Mail Room: 1B327, TL 152
(registered mail)

PSM - Supply Unit, 1B353
(not registered)

718027
MAILED 15
JAN 28 1980
FBI

REGISTERED MAIL
RETURN RECEIPT REQUESTED

FBI/DOJ

Shipping # _____

Shipping Method _____

COMPARISON CHART : VIDEO / STILL PHOTOGRAPHS / MOVIE FILM / ACQUSTICS

CHANNEL 11 (Video)	CHANNEL 2 (Video)	CHANNEL 12 (Video)	CHANNEL 8 (Film)	SHOT #	NARRATION
TIME COUNT	TIME COUNT	TIME COUNT	TIME COUNT		
11:28:12	N/A	: :	: :	1	
11:50:25	21:57:17	: :	: :	2	
11:54:28	22:01:21	: :	: :	3	
11:55:20	22:02:12	: :	: :	4	
12:00:03	22:06:25	: :	: :	5	
12:11:14	22:18:06	: :	: :	6	
12:12:02	22:18:21	: :	: :	7	
12:12:14	22:19:09	: :	: :	8	
12:12:16	22:19:10	: :	: :	9	
12:13:15	22:10:14	: :	: :	10	
12:18:00	22:24:26	: :	: :	11	
12:19:26	22:26:19	: :	: :	12	
12:20:04	22:26:25	: :	: :	13	
12:20:09	22:27:03	: :	: :	14	
12:20:16	22:27:15	: :	: :	15	
12:21:16	22:28:10	: :	: :	16	
12:21:21	22:28:18	: :	: :	17	
12:22:10	22:29:04	: :	: :	18	
12:22:14	22:29:10	: :	: :	19	
12:23:26	22:30:19	: :	: :	20	
12:24:23	22:31:16	: :	: :	21	
12:27:24	22:34:18	: :	: :	22	
12:28:20	22:35:12	: :	: :	23	
12:28:25	22:35:18	: :	: :	24	
12:30:05	22:36:28	: :	: :	25	
12:30:17	22:37:05	: :	: :	26	
12:31:00	22:37:29	: :	: :	27	
12:31:17	22:38:09	: :	: :	28	
12:31:28	22:38:17	: :	: :	29	
12:33:13	22:40:03	: :	: :	30	
30 fps	30 fps	30 fps	30 fps	point	

b6
b7c

APPROXIMATE

SEROLOGY

No gun oil was detected (gross observation) on specimen Q461.

No gunpowder residues were found in the pockets of specimen Q461.

No foreign textile fibers were found on Q462 through Q466 and Q468.

No textile fibers like those composing the clothing of Billy Franklin (Q66 through Q74 Laboratory number 91119065 S QY UF MC UQ RF RU) were found on Q470.

Yellow acrylic fibers were found on Q467.

The requested instrumental examinations are continuing and you will be subsequently advised of the results and as to the disposition of the submitted specimens.

Page 2

00212051 S/D QY UF MC RF UQ PN

REPORT
of the



FEDERAL BUREAU OF INVESTIGATION
WASHINGTON, D. C. 20535

To: Mr. W. E. Swing
Chief of Police
Greensboro, North Carolina 27420

January 14, 1980

Attention: Captain [redacted]
Staff Services Division

FBI FILE NO. 44-81521

LAB. NO. 91119065 S QY UF

Re: [redacted]

YOUR NO.

MC UQ
RF RU

b6
b7C

And others - SUSPECTS;
JAMES WALLER, WILLIAM SAMPSON,
VINCENT CAUCE, And others - VICTIMS;
CRIMINAL HOMICIDE/MURDER

G.P.D. #79-0145368

Examination requested by: Addressee

Reference: Letters dated November 14, 1979

Examination requested: Firearms - Microscopic Analyses - Chemical Analyses -
Instrumental Analyses - Metallurgy

Result of examination:

This report supplements the FBI Laboratory report relating to this case dated December 19, 1979. For a detailed listing of the submitted specimens, please refer to that report.

Grouping tests conducted on the known blood samples disclosed the following:

- K1 "O, PGM 2-1, EsD 1-1, EAP B, ADA 1-1, AK 1-1, Hp 1-1."
- K2 "A, EsD 1-1, EAP B, ADA 1-1, Hp2-1."
- K3 "O, EsD 1-1, EAP B, ADA 1-1, Hp 1-1."

This examination has been made with the understanding that the evidence is connected with an official investigation of a criminal matter and that the Laboratory report will be used for official purposes only, related to the investigation or a subsequent criminal prosecution. Authorization cannot be granted for the use of the Laboratory report in connection with a civil proceeding.

Page 1

(over)

FBI Rep
1-14-80

K4 "A, PGM 1-1, EsD 1-1, EAP B, AK 1-1, Hp 2-2."

K5 "O, EsD 1-1, EAP B, ADA 1-1, AK 1-1, Hp 2-1."

All positive results of examination are set forth above. Any other grouping tests which may have been conducted on these specimens were inconclusive.

Group "B" human blood was identified on specimens Q104, Q105, Q107 and Q305. Group "A" human blood was identified on specimens Q107 and Q109. Group "O" human blood was identified on specimen Q305. Grouping tests conducted on the human blood identified on specimens Q18 and Q108 were inconclusive. Human blood, too limited in amount for conclusive grouping purposes was identified on specimens Q16 through Q18, Q23, Q106, Q110 and Q111. Blood, too limited in amount for origin determination, was identified on specimens Q48, Q86 and Q113. No blood was found on specimens Q3 through Q15, Q19 through Q22, Q24 through Q47, Q49 through Q85, Q87 through Q103 or Q112.

The Instrumental examinations are continuing and you will be subsequently advised of the results and as to the disposition of the submitted items.

STATE BUREAU OF INVESTIGATION
AND
GREENSBORO POLICE DEPARTMENT
LABORATORY REPORTS

COMPAINT NUMBER

79-0145363

GREENSBORO POLICE DEPARTMENT
SUPPLEMENTARY REPORT

OFFENSE Criminal Homicide	3 CLASSIFICATION Murder	4 OFFICER [Redacted]	5 TIME & DATE OF REPORT 1340 4/2/79
6 TIME William E. Sampson & Others		7 VICTIM'S ADDRESS W/A	

THE INFORMATION BELOW IS CONFIDENTIAL - FOR USE BY AUTHORIZED POLICE PERSONNEL ONLY

The results of the latent fingerprint examination conducted by this writer are as follows. On 11/3/78, a total of six latent prints were recovered from weapons found in a yellow Ford Van. Two latent prints recovered from a .12-gauge Smith and Wesson shotgun, Serial 176964, were identified as having been made by suspect [Redacted]. Three latent fingerprints recovered from a .12-gauge single-barrel shotgun, Serial 380585, are unidentified at this time. A total of three latent palm impressions were recovered from the yellow Ford Van, license [Redacted]. In using the inked palm prints that are available at this time, I have been unable to effect an identification on any of the suspects. Two latent palm impressions of value and two latent fingerprints of value were recovered from a 1968 Ford Fairlane, license [Redacted]. In using the inked palm impressions now available, I am unable to effect an identification on any of the suspects. The latent fingerprints recovered from this vehicle are unidentified at this time. The following is a list of individuals who's inked impressions were examined and compared against latents recovered in this case.

b6
b7c

Suspects:

- (1) [Redacted]
- (2) [Redacted]
- (3) [Redacted]
- (4) [Redacted]
- (5) [Redacted]
- (6) [Redacted]
- (7) [Redacted]
- (8) [Redacted]
- (9) [Redacted]
- (10) [Redacted]
- (11) [Redacted]
- (12) [Redacted]
- (13) [Redacted]
- (14) [Redacted]
- (15) [Redacted]

b6
b7c

Victims:

- (1) William Eyan Sampson
- (2) James M. Waller
- (3) Ceasar Vincent Cauca
- (4) Sandy Haeley SMith

No further to report concerning the latent fingerprint examination at this time.

EW/dlz/47

4/3

04-1:42p

Cleared By Arrest

Exceptionally Cleared

Unfounded

Inactive

PS - POL - 87 - 544

Rec'd 7-13-82



NORTH CAROLINA
STATE BUREAU OF INVESTIGATION
DEPARTMENT OF JUSTICE



RUFUS L. EDMISTEN
ATTORNEY GENERAL

P. O. BOX 29500
3320 OLD GARNER RD.
RALEIGH 27626

HAYWOOD R. STARLING
DIRECTOR

July 12, 1982

[Redacted]

Greensboro Police Department
Drawer W-2
Greensboro, North Carolina 27402

Re: SBI Lab #RFT 79-00592

Dear [Redacted]:

The photograph you sent of the chart of the station wagon in question does give a general idea of the damage the station wagon had on it at the time of my examination.

I am enclosing four (4) pages of my notes that give the locations of nine (9) areas of damage in the front fender and a general idea of some of the small birdshot damaged areas. The second two pages give the locations of twenty-three (23) areas of damage to the rear portion of the station wagon.

b6
b7c

My charts submitted as states exhibits during the trial and the chart depicted in your photograph would all be helpful in illustrating the damage to the station.

As always, it is our desire to be of assistance in matters of mutual interest.

Sincerely,

[Redacted Signature]

Firearms & Tool Marks Examiner

STC:db

RFT 79-50

Good Fairmont
Passenger side front fender

Top line

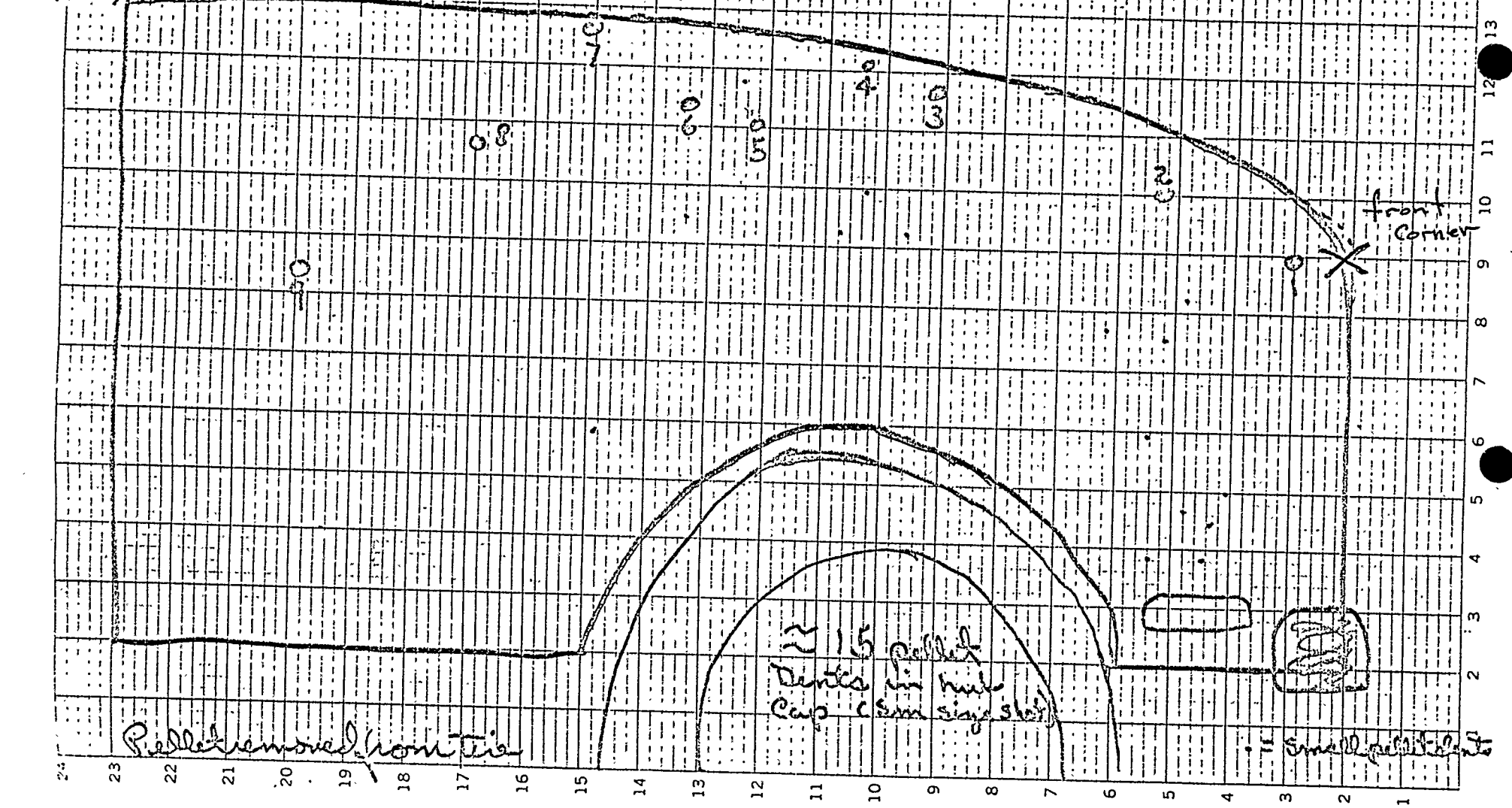

Pallet removed from tie

~ 15 pallet
dents in hub
cap (5mm size steel)

small pallet dent

Front fender of Ford Fairmont.

Note #

Distance from front corner

R7T79-592

Dist from top
in

1	2 1/2"	2"
2	18 1/2"	2"
3	25 1/2"	3/4"
4	28 1/4"	1/2"
5	31"	2 1/2"
6	33"	2"
7	36 1/2"	crease tops
8	48 1/2"	4"
9	52 1/2"	14"

Ford Fairmont.

rear Panel

Hole #

Dis. from roof corner

Distance from roof

Hole #	Dis. from roof corner	Distance from roof
1	48"	3"
2	40 1/2"	on seam
3	37 3/4"	2 3/4"
4	37 3/4"	4"
5	40"	6"
6	41 1/2"	7 1/2"
7	44 3/4"	17"
8	44"	15"
9	42 1/2"	9" Poss 19
10	37 1/2"	11"
11	36"	7"
12	34 3/4"	9"
13	34"	11"
22	44"	7"

Dent #
Hole #

Distance from Tail light

Dist. from window.

Dent # Hole #	Distance from Tail light	Dist. from window.
14	36"	9 1/2"
15	37"	13 1/2"
16	26"	1 1/2"
17	21"	5 1/2"
18	17"	on sill
19	13"	4"
20	14 3/4"	5 1/2"
21	14 1/2"	9 1/2"
23	41" from roof corner	30" to roof top

H-11

North Carolina
STATE BUREAU OF INVESTIGATION
Department of Justice
Raleigh

LABORATORY REPORT

<div style="border: 1px solid black; width: 150px; height: 20px; margin-bottom: 5px;"></div> Greensboro Police Dept. P. O. Drawer W-2 Greensboro, NC 27402	SBI FILE NO.: 180-T-8-235	DATE: December 18, 1979
	AGENCY FILE NO.: 79-145368	SBI LAB NO.: RCL7912338
	LOCATION: Guilford County	EXAMINED BY: <div style="border: 1px solid black; width: 100px; height: 15px; margin: 5px 0;"></div>
SUBJECT(S):	TYPE OF CASE:	MATERIAL SUBMITTED BY: <div style="border: 1px solid black; width: 100px; height: 15px; margin: 5px 0;"></div>
* SEE BELOW	Homicide & AWDWITKRSBI	DATE SUBMITTED: November 28, 1979

b6
b7C

*

ITEMS SUBMITTED:

- Item #1 - Manila envelope containing plastic bags with handwipings from
- Item #2 - Manila envelope containing plastic bags with handwipings from
- Item #3 - Manila envelope containing plastic bags with handwipings from
- Item #4 - Manila envelope containing plastic bags with handwipings from
- Item #5 - Manila envelope containing plastic bags with handwipings from
- Item #6 - Manila envelope containing plastic bags with handwipings from
- Item #7 - Manila envelope containing plastic bags with handwipings from
- Item #8 - Manila envelope containing plastic bags with hadnwipings from
- Item #9 - Manila envelope containing plastic bags with handwipings from
- Item #10 - Manila envelope containing plastic bags with handwipings from
- Item #11 - Manila envelope containing plastic bags with handwipings from
- Item #12 - Manila envelope containing plastic bags with handwipings from
- Item #13 - Manila envelope containing plastic bags with handwipings from

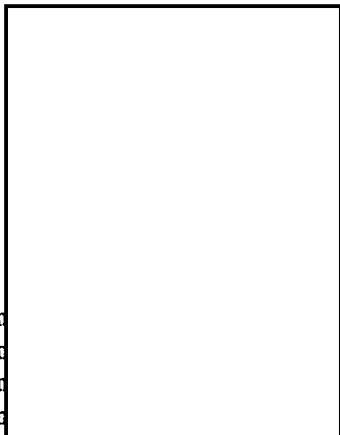

TYPE ANALYSIS REQUESTED:

Analyze the handwipings for the presence of gunshot residue.

RESULTS OF ANALYSIS:

Item #3 - Barium, antimony and lead, indicative of gunshot residue, were present in significant concentrations on each of the handwipings submitted. These results indicate that the subject could have fired a gun.

I, Rufus L. Edmisten, Attorney General of the State of North Carolina, hereby certify that the form identified as: North Carolina State Bureau of Investigation, Department of Justice, Laboratory Report, is a form approved by me for the purpose stated in G.S. 90-95 (g) and approved by me in compliance with the said statute.

COPIES TO:

THIS REPORT IS TO BE USED ONLY IN CONNECTION WITH AN OFFICIAL

This report represents a true and accurate result of my analysis on the item(s) described.



b6
b7C

RESULTS OF ANALYSIS CONTINUED:

Items #1, #2, #4-#13 - Barium, antimony and lead, indicative of gunshot residue were either not present in the proper concentrations or were not present in the proper locations on the handwipings submitted from these subjects. It is noted, however, that this does not eliminate the possibility that these subjects could have fired a gun.

DISPOSITION OF EVIDENCE:

The evidence is being returned via first-class mail.

MLC:paj
Attachment

BUREAU OF INVESTIGATION
NORTH CAROLINA DEPARTMENT OF JUSTICE
RALEIGH

Intra-Bureau Correspondence

From: S/A [REDACTED]

Date: November 7, 1979

To: The Files

File No.: 180-T-8-235
RFT 79-00592Subject: Crime Scene Investigation

In Reply To: CI-41

On November 3, 1979 Reporting Agent received a telephone call from Special Agent [REDACTED] requesting that the Firearms Unit assist in a crime scene investigation in Greensboro, North Carolina.

Reporting Agent and Special Agent [REDACTED] traveled to Greensboro, N. C., on November 4, 1979 and met with Special Agent [REDACTED] and [REDACTED] of the Greensboro Police Department's Lab.

The crime scene consisted of three (3) vehicles that were involved in a shooting.

b6
b7c

Vehicle #1 was a gold colored Ford van, N.C. license # [REDACTED]

On the passenger side of the cargo door was a graze mark caused by a small caliber bullet or possibly a buckshot pellet. This graze mark had a small amount of metal deposited in it. This metal deposit is similar in appearance to lead. No other bullet holes, dents or other firearms related evidence was recovered.

Vehicle #2 was a Ford Sport Custom pickup truck, green and white in color with N.C. license [REDACTED], and a black and white cab high camper shell.

The driver's side bottom window of the camper shell was partially missing. The remaining portion of window contained a bullet hole that corresponded to holes in the camper screen and window. Examination of the line formed by these three holes and the window glass reveals that the projectile causing these holes traveled from the rear of the camper, through the open door of the camper, through the curtain and screen, and exited out of the window.

Removed from the camper was a Martin and Company guitar that contained two (2) small pellet type holes and two (2) pellet type impressions in the upper side and two (2) holes in the lower side with a damaged area on the top. Two (2) small lead pellets were recovered from the inside of the guitar and blood stains are being preserved in the event blood typing is necessary. The two (2) pellets from the guitar are consistent in weight to number six (6) shot pellets.

180-T-8-235
RFT 79-00592
Page 2
November 7, 1979

Vehicle #3 was a Ford Fairmont white station wagon, N.C. license # [redacted]

b6
b7C

The driver's side exterior of the station wagon had no signs of damage except for the rear door window. The passenger's side front fender, wheel and hubcap were damaged. The passenger side front fender had nine (9) areas that appeared to have been struck by buckshot and numerous areas that appeared to have been struck by birdshot size pellets. The passenger side front tire was flat and the hubcap had approximately fifteen (15) dents that appear to have been caused by birdshot size pellets. Five (5) pellets were removed from the passenger side front tire. These pellets are consistent in weight to known number six (6) shot pellets. The rear passenger door and quarter panel on the passenger side had twenty-three (23) holes or dents that appeared to have been caused by buckshot pellets.

The small vent window on the rear passenger side door had three (3) holes in it. These holes were caused by pellets moving from the outside to the inside. Six (6) lead pellets or lead fragments were recovered from the rear portion of the station wagon. Two (2) of the pellets are consistent in weight to known OO Buck shot pellets. The remaining fragments are too deformed to determine their shot size.

Reporting Agent and Special Agent [redacted] completed their investigation and returned to Raleigh on November 4, 1979 at 2100 hours with the evidence collected. [redacted] of the Greensboro Police Department will submit additional evidence collected by his agency at a later date.

b6
b7C

STC:db

cc:-Special Agent [redacted]

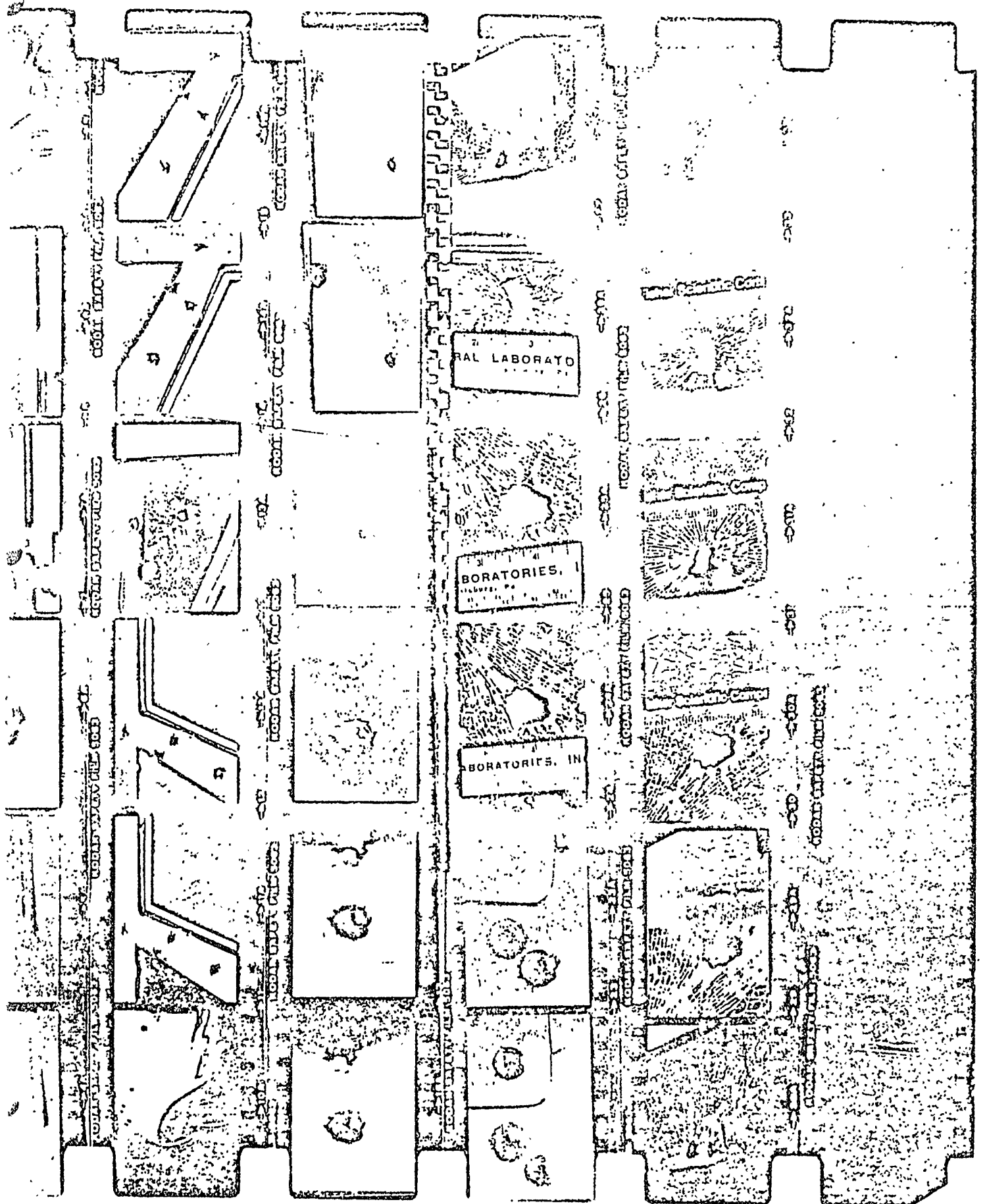

NORTH CAROLINA
STATE BUREAU OF INVESTIGATION
DEPARTMENT OF JUSTICE
3320 OLD GARNER ROAD
RALEIGH 27610

YWOOD R. STARLING
DIRECTOR

TYPE OF CASE: Homicide - Crime Scene Investigation

ISSUING AGENCY: Greensboro Police Department (Guilford Co)

ATTORNEY: J. M. Waller, C. V. Cauce, W. E. Samson, S. Smith, M. Nathan,

b6
b7C

SUBJECT: _____

DATE SUBMITTED: November 4, 1979

LABORATORY FILE #: 180-T-8-235

LABORATORY #: RFT 79-00592

Received from the State Bureau of Investigation the following described evidence:

- 1 - One (1) Martin and Company guitar.
- 2 - One (1) piece of glass.
- 3 - Seven (7) plastic bags containing pellets and metal fragments.

DATE: 11/13/79

(SIGNATURE)

b6
b7C

LABORATORY AMINER:

BUREAU OF INVESTIGATION
NORTH CAROLINA DEPARTMENT OF JUSTICE
RALEIGH

Intra-Bureau Correspondence

From: Special Agent [redacted]
To: The Director
Subject: CRIME SCENE INVESTIGATION

Date: January 8, 1980
File No.:
In Reply To: (79)-180-T-8-235 &
9-000-45

(Received WPC: January 11, 1980)
(Transcribed: February 1, 1980)

On Saturday, November 3, 1979, at approximately 1:00 P.M., Reporting Agent received a telephone call at his residence from Supervising Agent [redacted]. Agent [redacted] advised that at approximately 11:30 A.M., on November 3, 1979, that five (5) members of the Communist Workers Party had been shot and killed by a group of Ku Klux Klan Members. He further advised that this occurred during an Anti-Klan Rally in downtown Greensboro. Agent [redacted] requested Reporting Agent to proceed to the District Office and to notify the District Agents by telephone of the situation and to be on a stand-by status.

b6
b7c

At approximately 1:25 P.M., on Saturday, November 3, 1979, Reporting Agent arrived at the District Office and proceeded to contact several of the Northern Piedmont District Agents. Upon contacting Special Agent [redacted], Reporting Agent was advised that the Greensboro Police Department, Laboratory Supervisor, [redacted], had requested him to deliver a large number of gunshot residue tests to their laboratory in Greensboro.

b6
b7c

Reporting Agent advised Special Agent [redacted] to proceed on to the Greensboro Police Department, and that Reporting Agent would meet him there with the gunshot residue kits.

Reporting Agent arrived at the Greensboro Police Department at approximately 2:00 P.M., on November 3, 1979, and met with Lab Supervisor [redacted]. [redacted] requested Reporting Agent and Special Agent [redacted] to assist with the technical and the laboratory work in this case.

Special Agent [redacted] took a gunshot residue test from the hands of the following suspects that were arrested, and in custody, at the Greensboro Police Department:

b6
b7c

- (1) [redacted]
- (2) [redacted]
- (3) [redacted]
- (4) [redacted]
- (5) [redacted]

COPIES 2 5
AND ATTACHMENTS

(79)-180-T-8-235 &
79-000-45

(6) [redacted]

Reporting Agent took gunshot residue tests on the hands of the following suspects in custody at the Greensboro Police Department:

(7) [redacted]
(8) [redacted]
(9) [redacted]
(10) [redacted]
(11) [redacted]
(12) [redacted]
(13) [redacted]

b6
b7c

Reporting Agent further assisted the Greensboro Police Department Lab with the packaging and preservation of a large amount of evidence which had been seized from the crime scene and several vehicles.

Reporting Agent completed the technical assistance at approximately 11:30 P.M., on November 3, 1979.

On Sunday, November 4, 1979, at approximately 11:00 A.M., Reporting Agent met Special Agent [redacted] of the Firearms Laboratory in Raleigh at the Greensboro Police Department. Reporting Agent assisted Special Agent [redacted] with photographs and the examination of the following vehicles for firearms evidence. These vehicles were stored in the basement at the Greensboro Police Department parking lot.

Vehicle #1: 1974, yellow Ford Van; North Carolina License Number [redacted]; Vehicle Identification Number [redacted]. This vehicle appeared to have been grazed by a projectile on the right rear side door.

Vehicle #2: 1970 Ford pickup truck, white over green; North Carolina License Number [redacted]; Vehicle Identification Number [redacted]. This vehicle appeared to have been struck by at least one (1) shotgun blast on the left rear window of the camper shell.

b6
b7c

Vehicle #3: 1979, white, Ford Fairmont Station Wagon; North Carolina License Number [redacted]; Vehicle Identification Number [redacted]. This vehicle was marked and belonged to Television Station WXII, Channel 12, in Winston-Salem, North Carolina. This vehicle appeared to have been struck possibly twice in the right front fender and tire by a shotgun blast and possibly, three (3) times to the right rear window and fender with a shotgun blast.

(79)-180-T-8-235 &
79-000-45

Upon completion of the examination of these vehicles, Special Agent [redacted] advised that he would maintain custody of the evidence collected and submit a report as to his findings.

On Tuesday, November 6, 1979, at approximately 5:30 P.M., Reporting Agent received a telephone call at the Greensboro District Office from Greensboro Police Detective [redacted]. Detective [redacted] advised Reporting Agent that he was at the Winston-Salem Police Department and requested the Mobile Crime Laboratory to process an additional vehicle, which had been located and was involved in the shootings that occurred on November 3, 1979.

b6
b7C

Reporting Agent, assisted by Special Agent [redacted], arrived at the Winston-Salem Police Department at approximately 6:45 P.M., on November 6, 1979. At that time, Reporting Agent met with the following Officers of the Winston-Salem Police Department:

- (1)
- (2)
- (3)
- (4)
- (5)
- (6)



Also present at the meeting were Special Agents of the Alcohol, Tobacco, and Firearms Bureau:

- (1)
- (2)
- (3)

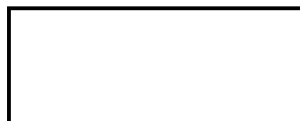

Detective [redacted], of the Greensboro Police Department, was also present, and advised Reporting Agent of the situation in reference to a 1962, Ford Fairlane, which was observed on the news films as leaving the scene of the shooting at the Anti-Klan Rally in Greensboro on November 3, 1979. At that time, the vehicle was known to contain the suspects which participated in the shooting and several weapons.

b6
b7C

Detective [redacted] advised Reporting Agent that he had in his possession a Search Warrant for this vehicle, and for the residence of [redacted] the owner of the vehicle.

Detective [redacted] advised that the vehicle was parked behind [redacted]'s residence at this time, and requested Reporting Agent to execute the Search Warrant upon arriving at the location.

(79)-180-T-8-235 &
79-000-45

On Tuesday, November 6, 1979, at approximately 7:25 P.M., Reporting Agent and all other Officers previously listed in this report, arrived at [redacted] Avenue, Winston-Salem, North Carolina. Upon arriving at this residence, Reporting Agent observed the blue, four door, 1962 Ford Fairlane, North Carolina License Number [redacted] parked in the yard at the rear of the residence.

Detective [redacted], ATF Agent [redacted] Special Agent [redacted], and Reporting Agent approached the rear door of the residence and were met by [redacted]

b6
b7C

Detective [redacted] advised [redacted] that he had a Search Warrant for the vehicle and her residence and requested Reporting Agent to execute the Search Warrant at that time. Reporting Agent read the Search Warrant to [redacted] at approximately 7:28 P.M.

Upon completion of the reading of the Search Warrant, Reporting Agent assisted Detective [redacted] and ATF Agent [redacted] by photographing the interior of the residence. Detective [redacted] took the items of evidence seized from the house into his custody at that time, which included several weapons, such as shotguns and rifles, ammunition of various types and calibers.

Reporting Agent noted and photographed several Ku Klux Klan items and paraphernalia, such as plaques, calendars, literature, and uniforms. Each of these items were photographed and were located mainly in the master bedroom of the house.

The search of the residence was completed at approximately 8:20 P.M.

At approximately 8:52 P.M., [redacted] arrived at the residence with a tow truck. [redacted] works for Spaugh Motor Company, Address: 160 West First Street, Winston-Salem, North Carolina. [redacted] then towed the 1962 Ford Fairlane from the [redacted] residence. Reporting Agent and other Investigating Officers followed the tow truck and vehicle to the basement parking lot of the Federal Building located at 251 North Main Street, Winston-Salem, North Carolina, arriving at approximately 9:15 P.M., on November 6, 1979.

b6
b7C

Reporting Agent then began the search of the vehicle, which was noted as being a 1962, light blue, four door, Ford Fairlane; North Carolina License Number [redacted]; Vehicle Identification Number [redacted].

All of the doors on the vehicle were locked, with the exception of the driver's door, and the windows were all closed.

(79)-180-T-8-235 &
79-000-45

Reporting Agent photographed the entire exterior and interior of the vehicle, and noted what appeared to be fresh scratch marks and residue of paper, possibly stickers that had been removed from the left rear bottom corner of the rear window, the left bottom corner of the trunk lid, the left rear side bumper, and the right rear side bumper.

Reporting Agent processed the vehicle for latent fingerprints and obtained nineteen (19) latent fingerprint lifts.

A copy of the Search Warrant and an inventory of all items of evidence seized from the [redacted] residence and the vehicle are attached to this report; See Attachment A.

The search of the vehicle was completed at approximately 12:10 A.M. on November 7, 1979, and the vehicle was driven by Special Agent [redacted] to the underground parking lot of the Greensboro Police Department. Reporting Agent followed [redacted] to that location, arriving at approximately 1:00 A.M. At that time, Special Agent [redacted] locked the vehicle and turned the keys over to Greensboro Detective [redacted]

b6
b7C

On November 8, 1979, Reporting Agent turned over to the Greensboro Police Department, Lab Supervisor, [redacted], all items of evidence seized from the 1962 Ford Fairlane; a receipt for which was obtained and a copy attached to this report; See Attachment B.

On November 28, 1979, Reporting Agent turned over to Special Agent [redacted] all of the gunshot residue tests taken of the suspects on November 3, 1979, which Special Agent [redacted] then turned over to Agent [redacted] of the Crime Laboratory on November 28, 1979.

b6
b7C

SJP/bg

cc: Supervising Agent [redacted]
SOD Supervisor [redacted]
Assistant Director Max Bryan

(79)-180-7-8-235 #A

STATE OF NORTH CAROLINA

File # _____

County of Guilford

Film # _____

In The General Court of Justice
District Court Division

In The Matter Of

a 1962 Ford Fairlane (light blue in color)
bearing North Carolina License plate
number

SEARCH WARRANT

b6
b7c

To any officer with authority and territorial jurisdiction to conduct the search authorized by this Warrant:

THE UNDERSIGNED FINDS THAT THERE IS PROBABLE CAUSE TO BELIEVE that the property described in the application on the reverse hereof and related to the commission of a crime is located as described in the application.

Therefore, you are commanded to search (those premises) (that vehicle) ~~(that person)~~ described in the application for the property in question. If this property is found, seize it and keep it subject to court order.

YOU ARE DIRECTED TO EXECUTE THIS WARRANT WITHIN FORTY-EIGHT (48) HOURS FROM THE TIME INDICATED BELOW AND MAKE DUE RETURN TO THE CLERK OF THE ISSUING COURT.

Issued this 6th day of November, 1979, at 4:30 o'clock P.m., upon information furnished under oath by the person or persons named below.

Name of Applicant

Thomas W. Dwyer

Assistant Deputy Clerk of Superior Court
Magistrate/District/Superior Court J

Name of Additional Affiant or Attestant

Name of Additional Affiant or Attestant

G.S. 15A-246; -244
AOC-L Form 284
7/75

b6
b7c

a 1962 Ford Fairlane (blue in color)
bearing N.C. license plate no. FD-494
SEARCH WARRANT

Issued 6th day of November, 199

RETURN

I hereby certify that on the 6th day of NOVEMBER, 1979 at 2:45 o'clock P.m. this warrant came into my hands.

On the 6th day of NOV, 1979 at 2:28 o'clock P.m., I made a search of WIN. SAL. N.C. 1962 FORD

1104

as therein commanded. () I seized the items listed on the attached inventory. () I did not seize any items.

This warrant was not executed within 48 hours of the date of issuance and I hereby mark it "not executed."

I return this search warrant this 2 day of Nov, 1979 at 1:30 o'clock P.m.

Signature Special Agent SRS
Title and Agency

This search warrant was returned to me on the 6th day of November, 1979 at 4:30 o'clock P.m.

Assistant Deputy Clerk of Superior Court

I, [redacted] Detective, Greensboro Police Department, being (Insert name and address; or, if a law officer, insert name, rank and agency)

fully sworn, hereby request that the court issue a warrant to search the (person) (place) (vehicle) described in this application and to find and seize the items described in this application. There is probable cause to believe that certain property, to wit:

1962 Ford Fairlane, light blue in color, bearing North Carolina License Plate Number [redacted], believed to contain semi-automatic weapons, shotguns, handguns and ammunition for same. (and/or automatic weapons)

constitutes evidence of) (constitutes evidence of the identity of a person participating in) a crime, to wit: Murder

and the property is located (in the place) (in the vehicle) (on the person) described as follows: (Unmistakably describe the building, premises, vehicle or person -- or combination -- to be searched.) a 1962 Ford Fairlane, light blue in color, bearing N.C. License No. [redacted] believed to be located at [redacted] Avenue, Winston-Salem, North Carolina and one-half story white frame house with porch on front; on east side of [redacted] Ave.

The applicant swears to the following facts to establish probable cause for the issuance of a search warrant: Shortly after 11:00 a.m. on November 3, 1979, several persons were fatally wounded by firearms near the intersection of Everitte Street and Carver Street Greensboro, North Carolina. The Greensboro Police Department has identified some of the victims as James Michael Waller, Cesar V. Cauce and Sandy Smith. This homicide is being investigated by the Greensboro Police Department, noted as Case No. 790145368.

This affiant has determined that persons from the news media were present at the scene of the fatal shootings and photographed and filmed several vehicles present and the affiant obtained these photographs which also have appeared in several editions of the Greensboro News and the videofilm which has been presented on the Channel 2 television news coverage, Monday, November 3, 1979. Photostat copies of some of these photographs are attached to this application and numbered G.P.D. #1 through #3.

On or about November 5, 1979, one [redacted] of [redacted] Street, Greensboro came to the Greensboro Police Department on his own initiative and advised the affiant that [redacted] had been near the laundromat near the intersection of Everitte Street and Carver Drive before 11:00 a.m. November 3rd and that he observed three or four cars near that intersection. He stated that of these vehicles, one was an older model Ford Fairlane, model early 1960's, containing several white males. [redacted] further stated that he observed white males exit from the vehicle and begin firing weapons, at least one being an automatic toward a vehicle which appeared to be owned by a television station. This affiant has known [redacted] for some time and knows of (*Continue if necessary.)

to and subscribed before me
this 5th day of November, 1979.

SEE ATTACHMENT.

James W. Seay
Deputy Clerk of Superior Court
District/Superior Court Judge

[redacted signature]
Signature of Applicant

In addition to the allegations of fact included in this application, this application is supported by affidavits attached, made by [redacted]

In addition to the allegations of fact included above, this application is supported by sworn testimony, given by [redacted] and reduced to writing by me and filed with the clerk.

Assistant Deputy Clerk of Superior Court
Magistrate/District/Superior Court Judge

If a continuation is necessary, continue the statement on an attached sheet of paper with a notation saying "see attachment." Date the continuation and include on it the names of applicant and issuing official.

STATE OF NORTH CAROLINA
GUILFORD COUNTY

File Number: _____

IN THE GENERAL COURT OF JUSTICE
DISTRICT COURT DIVISION

IN THE MATTER OF:)
a 1962 Ford Fairlane, light blue in color,)
bearing N.C. License [redacted], believed)
to be located at [redacted] Avenue,)
Winston-Salem, N.C.)
_____)
_____)

ATTACHMENT TO APPLICATION
FOR SEARCH WARRANT

Page 2 of 2 pages

no reason for [redacted] to be untruthful in his statements. The description [redacted] gave regarding the Ford Fairlane meets the appearance of the Ford Fairlane depicted in the aforementioned photographs. b6 b7C

The affiant has studied enlargements of the aforementioned photographs and can observe the license plate number on said Ford Fairlane vehicle. The letters and numbers on this plate appear as [redacted]. The affiant has checked with the Department Of Motor Vehicles Records Division in Raleigh, N.C. and said vehicle is recorded as registered to one [redacted] of Winston-Salem, N.C. [redacted] has been arrested for murder arising out of the shootings mentioned above. [redacted] has been formally charged with Conspiracy to Commit Murder.

Within the last twelve hours, this affiant has been advised by Sergeant [redacted] of the Winston-Salem Police Department that he [redacted] had personally observed the above described vehicle at [redacted] Avenue, Winston-Salem, N.C.

This affiant has interviewed one [redacted] [redacted] an [redacted] arising out of the aforementioned shootings. [redacted] has advised this affiant that [redacted] of the shootings that he had observed weapons in the trunk of the Ford Fairlane vehicle and that he, while at the scene of the shooting near the intersection of Everitte Street and Carver Drive, observed this Ford Fairlane in front of him. [redacted] made this statement to this affiant after he [redacted] had [redacted] and after he [redacted] and agreed to make a statement.

Sgt. [redacted] further advised this affiant that he [redacted] with [redacted] and that [redacted] had told him [redacted] that he lived at [redacted] Avenue, Winston-Salem, N.C. b6 b7C

Based on the foregoing facts, this affiant has probable cause to believe that the above described vehicle and weapons are located at [redacted] Avenue, Winston-Salem, N.C. The affiant requests the Court to issue a warrant to search the aforementioned premises for the Ford Fairlane described above and to search said vehicle and residence for the weapons described in the application and for fingerprint impressions, hair samples and other evidence of the identity of the occupants most recently in said vehicle and who may have handled said weapons.

This affiant has probable cause to believe that said weapons are either in the aforementioned vehicle or in the above described residence, in as much as the suspect [redacted] has identified this residence as his home. The affiant further requests that any warrant issued authorize the search and seizure of said Ford Fairlane vehicle at any point on the public street or highway if said vehicle is not found at said residence.

[redacted]
Signature of Applicant

Sworn to and subscribed before me
this 6th day of November, 19 79.

Thomas W. Seay, Jr.
Assistant Deputy Clerk of Superior Court
Magistrate/District/Superior Court Judge

AOC-L Form 284-Continuation

8/15/75 (1500)
CSC-192



b6
b7C

UNIVERSITY OF
MICHIGAN LIBRARY

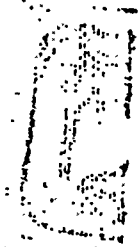

UNIVERSITY OF
MICHIGAN LIBRARY

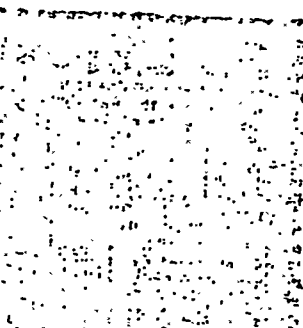

UNIVERSITY OF
MICHIGAN LIBRARY

UNIVERSITY OF
MICHIGAN LIBRARY

UNIVERSITY OF
MICHIGAN LIBRARY

UNIVERSITY OF
MICHIGAN LIBRARY

G.P.D. # 1

11-6-79
10:30 PM
HGB

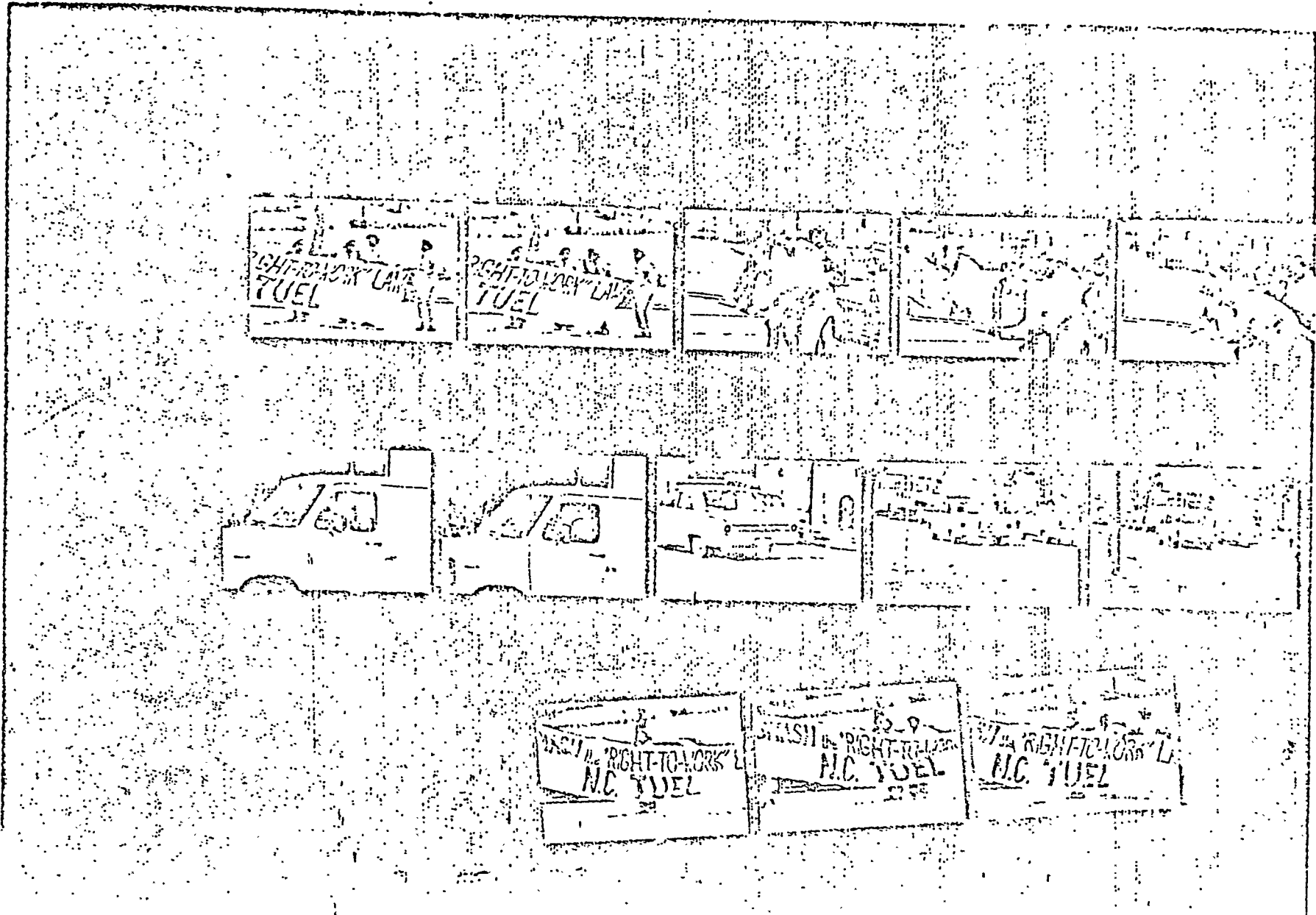

STATE OF NORTH CAROLINA
County of Guilford

File # _____
Film # _____
In The General Court of Justice
_____ Court Division

In The Matter Of

~~a 1962 Ford Fairlane (light blue in color) bearing North Carolina License Plate~~ - INVENTORY OF SEIZED PROPERTY
number

I, , the undersigned officer, b6
b7C
on the 6 day of November, 1979 executed a search of

a 1962 Ford Fairlane (light blue in color) bearing N.C. License plate number
and a house located at Avenue, Winston-Salem, North Carolina
(identify person, place, or vehicle searched)
pursuant to

- a search warrant issued by Thomas W. Seay, Superior Court Judge
- a consent to the search given by _____
- other legal justification for the search: _____

and seized the following items:

SEE ATTACHMENT.....

I am leaving a copy of this inventory

- with the person who consented to the search, named above.
- with the owner of the place searched, _____
- with the person (from whom the items were seized) (in apparent control of the place searched) (identify person)
- in the place searched, identified above. b6
b7C

The law enforcement agency identified below will hold the seized property, subject to court order.

Subscribed and sworn to before
me this _____ day of _____,
19____.

Law Enforcement Officer
Special Agent S.B.I. and Detective, Special Agent
Title G.P.D.
S.B.I. and G.P.D.
Agency

Assistant Deputy Clerk of Superior Court
Magistrate

This is to acknowledge that on the _____ day of _____, 19____,
I received a copy of this inventory.

Signature of Recipient

Inventory of items seized during search of residence at [redacted] Ave.,
Winston Salem, N. C. 11/6/79 pursuant to search warrant issued November
6, 1979:

b6
b7c

1. Mini 14 Ruger 223, semi automatic rifle, one leather strap, one 20 round clip (loaded) ser. no. 181-27138.
2. Skinkosha Japan, FIE model SB-4 12 ga. shotgun, 2 3/4 inch FIE model SB4.
3. Double barrel 12 ga. shotgun, American Gun Company, New York, Knickerbacker, loaded 2 shell (00 buck).
4. Remington Speed Master, 22 cal. long rifle (14 shells), model 552, semi automatic ser. 1713799.
5. White bag containing 13 double 00 buckshot one No. 6 shot, 4 shell slugs, 1 oz. Western.
6. Brown paper bag containing 8 red boxes of 223 Rem. Police cartridges, approx. 50 rounds, Winchester box assortment rounds.
7. (4) 45 cal. bullets, 1 gas mask in white bag (9) 223 bullets and (1) .38 cal. found in living room on table.
8. (2) 12 ga. 00 buck shells, from double barrel shotgun (14) 22 cal. shells from 22 rifle found under living room couch pillows.
9. One scout knife and sheaf found living room dresser.
10. One O.D. green colored bag approx. 1000 rounds 22 cal. One Army ammo can containing approx. 1000 round .38 cal.

Inventory of items seized during search of 1962 Ford Fairlane Lic. # [redacted]
pursuant to search warrant issued 11/6/79.

One 1962 Ford Fairlane Lic. # [redacted]

1. 19 latent fingerprint lifts.
2. 6-357 mag. cartridge cases.
3. 3-38 cal. cartridge cases.
4. 1 00 buck, 12 ga. shell.
5. 1 rifle slug, 12 ga.
6. 1 Red, white and black NAZIS arm band.
7. 1 white paper towel.
8. 1 pocket knife.
9. Miscellaneous papers from glove compartment.
10. One white plastic bag.
11. One receipt for 1-AR-15 in name of [redacted]
12. Miscellaneous paper from back seat.

b6
b7c

Inventory seized during search of 1962 Ford Fairlane Lic. #

b6
b7C

13. White paper bag.

14. Receipt for 1 Dan Wesson in trade for star BM 9MM in name of

15. Blood stained hubcap from right front wheel.

FBI LABORATORY REPORTS

BALLISTICS